



# basic education

Department:  
Basic Education  
**REPUBLIC OF SOUTH AFRICA**

NATIONAL  
SENIOR CERTIFICATE/  
NASIONALE  
SENIOR SERTIFIKAAT

**GRADE 12/GRAAD 12**

**MATHEMATICS P2/WISKUNDE V2**

**NOVEMBER 2022**

**MARKING GUIDELINES/NASIENRIGLYNE**

**MARKS/PUNTE: 150**

**DEPARTMENT OF BASIC  
EDUCATION**

PRIVATE BAG X896, PRETORIA 0001

2022 -11- 16

**APPROVED MARKING GUIDELINE**

**PUBLIC EXAMINATION**

**These marking guidelines consist of 24 pages.  
Hierdie nasienriglyne bestaan uit 24 bladsye.**

Approved by Umalusi External Moderator  
16/11/2002

Copyright reserved/Kopiereg voorbehou

Please turn over/Blaai om asseblief

**NOTE:**

- If a candidate answers a question **TWICE**, only mark the **FIRST** attempt.
- If a candidate has crossed out an attempt of a question and not redone the question, mark the crossed out version.
- Consistent accuracy applies in **ALL** aspects of the marking memorandum. Stop marking at the second calculation error.
- Assuming answers/values in order to solve a problem is **NOT** acceptable.

**NOTA:**

- As 'n kandidaat 'n vraag **TWEE KEER** beantwoord, merk slegs die **EERSTE** poging.
- As 'n kandidaat 'n antwoord van 'n vraag doodtrek en nie oordoen nie, merk die doodgetrekte poging.
- Volgehoue akkuraatheid word in **ALLE** aspekte van die memorandum toegepas. Hou op nasien by die tweede berekeningsfout.
- Aanvaar van antwoorde/waardes om 'n probleem op te los, word **NIE** toegelaat nie.

<b>GEOMETRY/MEETKUNDE</b>	
<b>S</b>	A mark for a correct statement (A statement mark is independent of a reason)
	<i>'n Punt vir 'n korrekte bewering</i> ( <i>'n Punt vir 'n bewering is onafhanklik van die rede</i> )
<b>R</b>	A mark for the correct reason (A reason mark may only be awarded if the statement is correct)
	<i>'n Punt vir 'n korrekte rede</i> ( <i>'n Punt word slegs vir die rede toegeken as die bewering korrek is</i> )
<b>S/R</b>	Award a mark if statement <b>AND</b> reason are both correct
	<i>Ken 'n punt toe as die bewering <b>EN</b> rede beide korrek is</i>

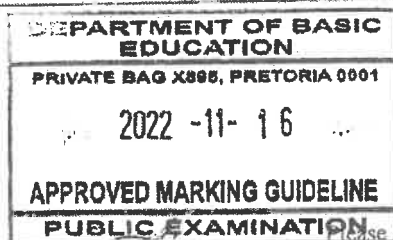

*G. ...*

QUESTION/VRAAG 1

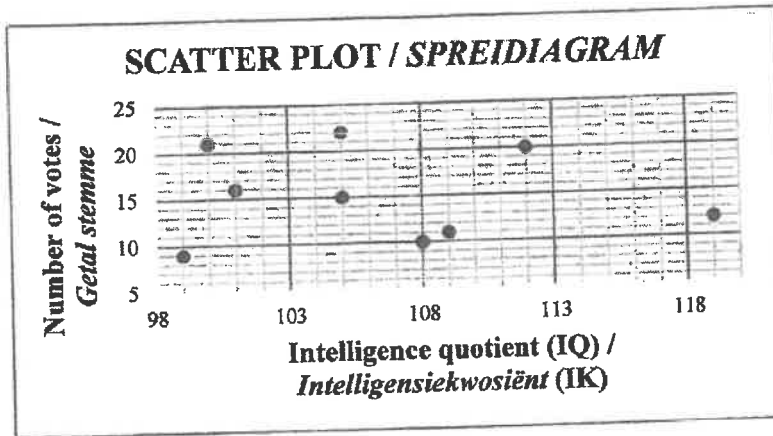

Popularity score (x) Gewildheidspunt (x)	32	89	35	82	50	59	81	40	79	65
Number of votes (y) Getal stemme (y)	9	22	10	21	11	15	20	12	19	16

1.1.1	$\bar{y} = \frac{155}{10}$ $= 15,5$	<div style="border: 1px solid black; padding: 5px; display: inline-block;">ANSWER ONLY: Full marks</div>	✓ 155 ✓ answer (2)
1.1.2	SD = 4,59		✓ answer (1)
1.2	$\bar{y} - SD$ $= 15,5 - 4,59$ $= 10,91$ $\therefore 10 - 2 = 8$ learners		✓ value of $\bar{y} - SD$ ✓ answer (2)
1.3	$a = 1,7709...$ $b = 0,2243...$ $\hat{y} = 1,77 + 0,22x$		✓ a ✓ b ✓ equation (3)
1.4	$\hat{y} = 1,77 + 0,22(72)$ $= 17,61$ $\approx 18$ votes <b>OR/OF</b> $\hat{y} = 17,92 \approx 18$ votes		✓ substitution ✓ answer (2)  ✓✓ answer (2)
1.5.1	Points are all scattered therefore low correlation and unrealistic prediction. / Punte is versprei daarom 'n lae korrelasie en onrealistiese voorspelling.		✓ R (1)
1.5.2	$r = 0,98$ /correlation very strong/korrelasie baie sterk $\therefore$ a reliable prediction/'n betroubare voorspelling		✓ S (1)
			<b>[12]</b>

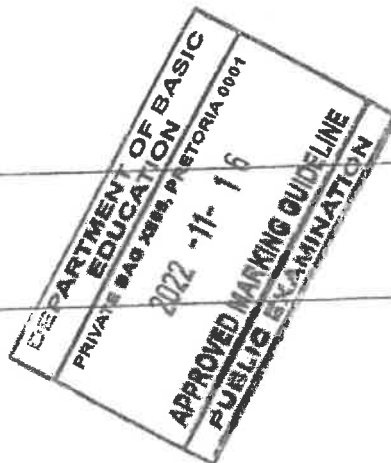

QUESTION/VRAAG 2

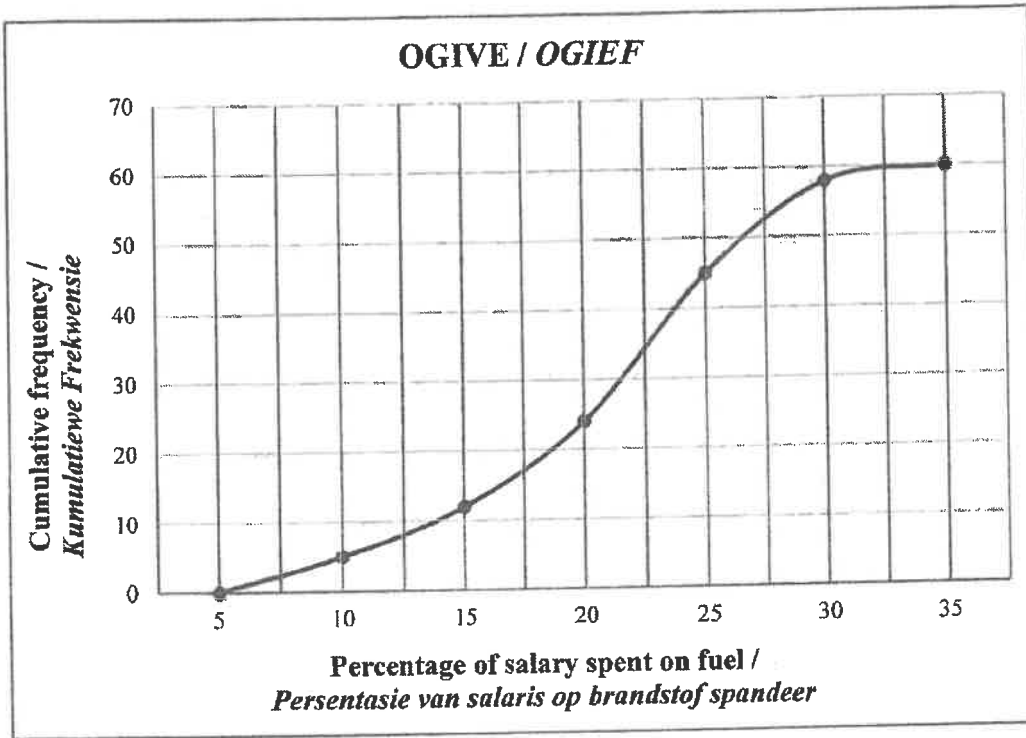

2.1	60 employees	✓ answer (A)	(1)
2.2	$20 < x \leq 25$	✓ answer	(1)
2.3	60 – 34 = 26 employees	ANSWER ONLY: Full marks ✓ 34 ✓ answer	(2)
2.4	Salary = $\frac{100}{7} \times 2400$ Salary = R34 285,71	ANSWER ONLY: Full marks ✓ method ✓ answer	(2)
2.5	∴ Ogive/Cumulative frequency graph will shift to the right/will become steeper. ∴ Ogief/Kumulatiewe frekwensie grafiek sal na regs skuif/sal steiler wees.	✓✓ answer	(2)
			[8]

DEPARTMENT OF BASIC  
EDUCATION  
PRIVATE BAG X896, PRETORIA 0001  
2022 -11- 16  
APPROVED MARKING GUIDELINE  
PUBLIC EXAMINATION

**QUESTION/VRAAG 3**

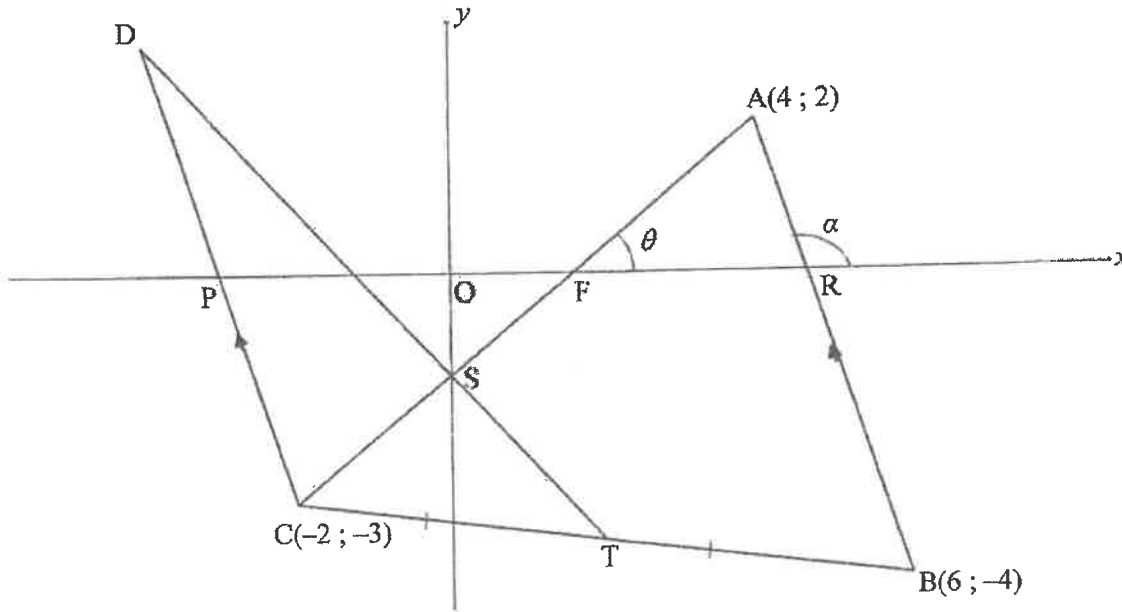

DEPARTMENT OF BASIC EDUCATION  
 PRIVATE BAG 9386, PRETORIA 0001  
 2022 -11- 16  
 APPROVED MARKING GUIDELINE

3.1.1	$m_{AB} = \frac{2 - (-4)}{4 - 6}$ OR $m_{AB} = \frac{-4 - 2}{6 - 4}$ $m_{AB} = -3$ <div style="border: 1px solid black; padding: 2px; display: inline-block;">ANSWER ONLY: Full marks</div>	✓ substitution ✓ answer (2)
3.1.2	$\tan \alpha = m_{AB} = -3$ $\alpha = 108,43^\circ$ <div style="border: 1px solid black; padding: 2px; display: inline-block;">ANSWER ONLY: Full marks</div>	✓ $\tan \alpha = m_{AB} = -3$ ✓ answer (2)
3.1.3	$T\left(\frac{x_1 + x_2}{2}; \frac{y_1 + y_2}{2}\right)$ $T\left(\frac{-2 + 6}{2}; \frac{-3 - 4}{2}\right)$ $T\left(2; \frac{-7}{2}\right)$	✓ $x_T = 2$ ✓ $y_T = \frac{-7}{2}$ (2)
3.1.4	$5(0) - 6y = 8$ $y = -\frac{4}{3}$ $S\left(0; \frac{-4}{3}\right)$	✓ $x_s = 0$ ✓ $y_s = \frac{-4}{3}$ (2)
3.2	$m_{CD} = m_{AB} = -3$ $-3 = -3(-2) + c$ OR $y - (-3) = -3(x - (-2))$ $c = -9$ $y = -3x - 9$ $y = -3x - 9$	✓ gradient ✓ substitution of C(-2; -3) ✓ equation (3)

<p>3.3.1</p>	$5x - 6y = 8$ $y = \frac{5}{6}x - \frac{8}{6}$ $\tan \theta = m_{AC} = \frac{5}{6}$ $\theta = 39,81^\circ$ $\hat{A} = 108,43^\circ - 39,81^\circ$ $= 68,62^\circ$ $\hat{DCA} = 68,62^\circ \quad [\text{alt } \angle\text{s}; DC \parallel AB]$	$\checkmark \tan \theta = m_{AC} = \frac{5}{6}$ $\checkmark \theta = 39,81^\circ$ $\checkmark \hat{A} = 68,62^\circ$ $\checkmark \text{answer}$ <p style="text-align: right;">(4)</p>
<p>3.3.2</p>	<p>P(-3;0) and F(1,6;0)</p> <p>Area POSC = Area <math>\Delta</math>FPC - Area <math>\Delta</math>OFS</p> $= \frac{1}{2}(4,6)(3) - \frac{1}{2}(1,6)\left(\frac{4}{3}\right)$ $= 6,9 - 1,07$ $= 5,83 \text{ units}^2$ <p><b>OR/OF</b></p> <p>P(-3;0)</p> $FC = \sqrt{\left(-2 - \frac{8}{5}\right)^2 + (-3 - 0)^2} = \frac{3\sqrt{61}}{5}$ $\text{Area } \Delta \text{PFC} = \frac{1}{2}(\text{PF})(\text{FC})\sin \hat{OFS}$ $= \frac{1}{2}\left(\frac{23}{5}\right)\left(\frac{3\sqrt{61}}{5}\right)\sin 39,81^\circ$ $= 6,90$ $\text{Area } \Delta \text{OFS} = \frac{1}{2}\left(\frac{8}{5}\right)\left(\frac{4}{3}\right)$ $= 1,07$ <p>Area POSC = 6,90 - 1,07</p> $= 5,83 \text{ units}^2$ <p><b>OR/OF</b></p>	$\checkmark P(-3;0)$ $\checkmark \text{method}$ $\checkmark \frac{1}{2}(4,6)(3)$ $\checkmark \frac{1}{2}(1,6)\left(\frac{4}{3}\right)$ $\checkmark \text{answer}$ <p style="text-align: right;">(5)</p> $\checkmark P(-3;0)$ $\checkmark \frac{1}{2}\left(\frac{23}{5}\right)\left(\frac{3\sqrt{61}}{5}\right)\sin 39,81^\circ$ $\checkmark \frac{1}{2}\left(\frac{8}{5}\right)\left(\frac{4}{3}\right)$ $\checkmark \text{method}$ $\checkmark \text{answer}$ <p style="text-align: right;">(5)</p>

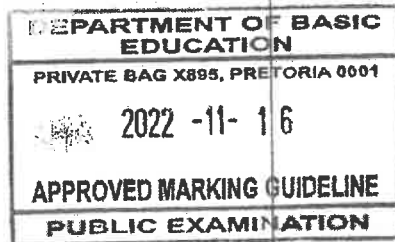

*Handwritten signature*

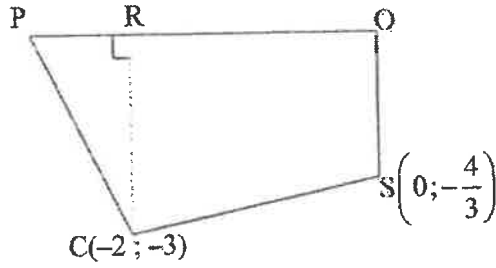

$P(-3;0)$

Area of POSC = Area of OSCR + Area of  $\Delta$ PRC

$$= \frac{1}{2} \left( \frac{4}{3} + 3 \right) \times 2 + \frac{1}{2} (1 \times 3)$$

$$= \frac{35}{6}$$

$$= 5,83 \text{ units}^2$$

OR/OF

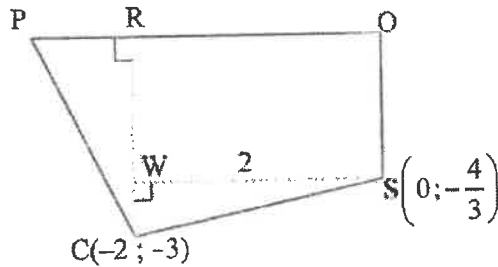

$P(-3;0)$

Area POSC = Area ROSW + Area  $\Delta$ PRC + Area  $\Delta$ WSC

$$= \left( \frac{4}{3} \right) (2) + \frac{1}{2} (1)(3) + \frac{1}{2} (2) \left( \frac{5}{3} \right)$$

$$= \frac{35}{6}$$

$$= 5,83 \text{ units}^2$$

OR/OF

✓  $P(-3;0)$

✓ method

✓  $\frac{1}{2} \left( \frac{4}{3} + 3 \right) \times 2$  ✓  $\frac{1}{2} (1 \times 3)$

✓ answer

(5)

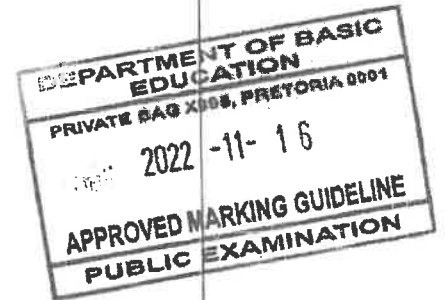

✓  $P(-3;0)$

✓ method

✓  $\frac{1}{2} (1)(3)$

✓  $\left( \frac{4}{3} \right) (2) + \frac{1}{2} (2) \left( \frac{5}{3} \right)$

✓ answer

(5)

<p><math>P(-3;0)</math></p> <p>Area of <math>\Delta PSC = \frac{1}{2}(PC)(CS)\sin \hat{DCA}</math></p> $= \frac{1}{2}(\sqrt{10})\left(\frac{\sqrt{61}}{3}\right)\sin 68,62^\circ$ $= 3,833..$ <p>Area of <math>\Delta POS = \frac{1}{2}(PO)(OS)</math></p> $= \frac{1}{2}(3)\left(\frac{4}{3}\right)$ $= 2$ <p>Area POSC = 3,833... + 2</p> $= 5,83\text{units}^2$	<p>✓ <math>P(-3;0)</math></p> $\checkmark \frac{1}{2}(\sqrt{10})\left(\frac{\sqrt{61}}{3}\right)\sin 68,62^\circ$  $\checkmark \frac{1}{2}(3)\left(\frac{4}{3}\right)$ <p>✓ method</p> <p>✓ answer</p> <p style="text-align: right;">(5)</p>
<b>[20]</b>	

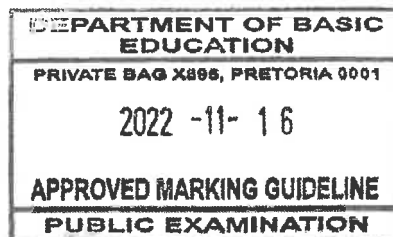



QUESTION/VRAAG 4

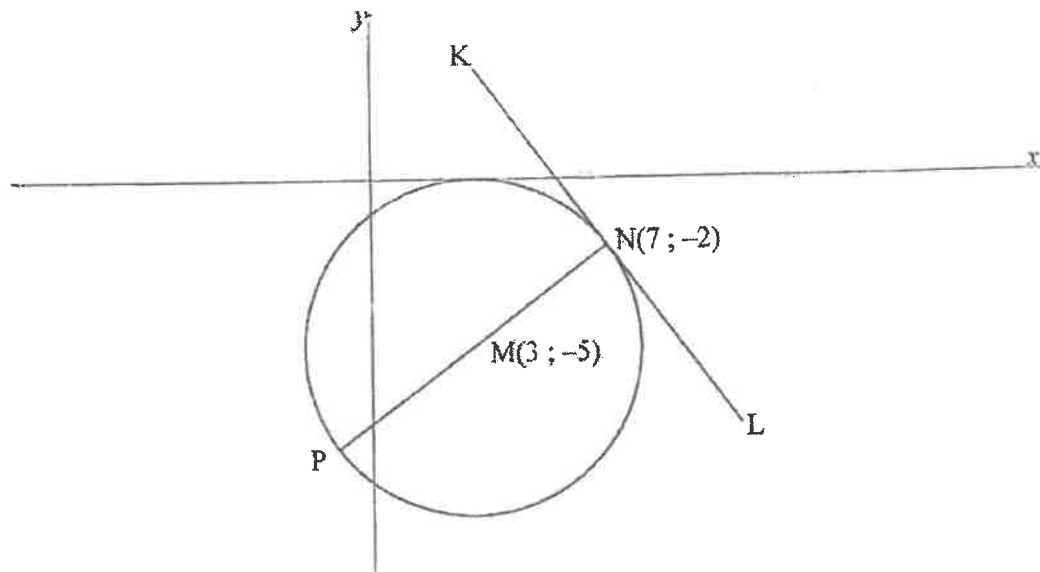

<p>4.1</p>	<p><math>P(x; y); N(7; -2); M(3; -5)</math>  <math>\frac{x+7}{2}=3 \quad \frac{y-2}{2}=-5</math>  <math>x=-1 \quad y=-8</math>  <math>P(-1; -8)</math></p>	<p>✓ <math>x_p = -1</math> ✓ <math>y_p = -8</math>                  (2)</p>
<p>4.2.1</p>	<p><math>r^2 = (7-3)^2 + (-2-(-5))^2</math> <b>OR/OF</b> <math>r^2 = (-1-3)^2 + (-8-(-5))^2</math>  <math>r^2 = 25</math>  <math>(x-3)^2 + (y+5)^2 = 25</math></p>	<p>✓ substitution into distance formula                  ✓ <math>(x-3)^2 + (y+5)^2</math>                  ✓ <math>r^2 = 25</math>                  (3)</p>
<p>4.2.2</p>	<p><math>m_{\text{radius}} = \frac{-5-(-2)}{3-7} = \frac{3}{4}</math>  <math>m_{\text{tangent}} = -\frac{4}{3}</math> [radius <math>\perp</math> tangent/raaklyn <math>\perp</math> radius]  <math>-2 = -\frac{4}{3}(7) + c</math> <b>OR</b> <math>y - (-2) = -\frac{4}{3}(x-7)</math>  <math>c = \frac{22}{3}</math> <math>y = -\frac{4}{3}x + \frac{22}{3}</math></p>	<p>✓ substitution                  ✓ <math>m_{\text{radius}} = \frac{-3}{4} = \frac{3}{4}</math>                  ✓ <math>m_{\text{tangent}} = -\frac{4}{3}</math>                  ✓ substitution of <math>m</math> and <math>N(7; -2)</math>                  ✓ equation                  (5)</p>
<p>4.3</p>	<p><math>-8 = -\frac{4}{3}(-1) + c</math>  <math>\therefore c = -\frac{28}{3}</math>  <math>-\frac{28}{3} &lt; k &lt; \frac{22}{3}</math></p>	<p>✓ subst <math>m</math> and <math>P</math>                  ✓ value of <math>c</math>                  ✓✓ answer                  (4)</p>

**DEPARTMENT OF BASIC EDUCATION**  
 PRIVATE BAG X895, PRETORIA 0001  
 2022 -11- 16  
**APPROVED MARKING GUIDELINE**  
**PUBLIC EXAMINATION**

<p>4.4.1</p>	<p><math>AB^2 = AM^2 - MB^2</math></p> <p><math>AB^2 = [(t-3)^2 + (t+5)^2] - 5^2</math></p> <p><math>= t^2 - 6t + 9 + t^2 + 10t + 25 - 25</math></p> <p><math>AB = \sqrt{2t^2 + 4t + 9}</math></p>	<p>✓ substitution into Pythagoras</p> <p>✓ simplification (A)</p> <p>(2)</p>
<p>4.4.2</p>	<p><math>t = \frac{-4}{2(2)}</math></p> <p><math>= -1</math></p> <p>Minimum at <math>t = -1</math></p> <p><math>AB = \sqrt{2(-1)^2 + 4(-1) + 9}</math></p> <p><math>AB = \sqrt{7}</math></p> <p><b>OR/OF</b></p> <p><math>4t + 4 = 0</math></p> <p><math>t = -1</math></p> <p>Minimum at <math>t = -1</math></p> <p><math>AB = \sqrt{2(-1)^2 + 4(-1) + 9}</math></p> <p><math>AB = \sqrt{7}</math></p> <p><b>OR/OF</b></p> <p>Length of <math>AB = \sqrt{2t^2 + 4t + 9}</math></p> <p><math>= \sqrt{2\left(t^2 + 2t + \frac{9}{2}\right)}</math></p> <p><math>= \sqrt{2\left[(t+1)^2 + \frac{7}{2}\right]}</math></p> <p><math>= \sqrt{2(t+1)^2 + 7}</math></p> <p>Minimum at <math>t = -1</math></p> <p><math>AB = \sqrt{2(-1)^2 + 4(-1) + 9}</math></p> <p><math>AB = \sqrt{7}</math></p>	<p>✓ substitution into correct formula</p> <p>✓ <math>t = -1</math></p> <p>✓ substitution</p> <p>✓ answer</p> <p>(4)</p> <p>✓ derivative = 0</p> <p>✓ <math>t = -1</math></p> <p>✓ substitution</p> <p>✓ answer</p> <p>(4)</p> <p>✓ completing of the square</p> <p>✓ <math>t = -1</math></p> <p>✓ substitution</p> <p>✓ answer</p> <p>(4)</p>
<p>DEPARTMENT OF BASIC EDUCATION</p> <p>PRIVATE BAG 2888, PRETORIA 0001</p> <p>2022 -11- 16</p> <p>APPROVED MARKING GUIDELINE</p> <p>PUBLIC EXAMINATION</p>		<p>[20]</p>

**QUESTION/VRAAG 5**

5.1.1	$\sin(360^\circ + x)$ $= \sin x$	$\checkmark + \checkmark \sin x$ (2)
5.1.2	$x\text{-coordinate} = \sqrt{(\sqrt{13})^2 - (-3)^2}$ $= -2$ $\tan x = \frac{-3}{-2}$ $= \frac{3}{2}$ <p><b>OR/OF</b></p> $x\text{-coordinate} = \sqrt{(\sqrt{13})^2 - (3)^2}$ $= 2$ $\tan x = \frac{3}{2}$	$\checkmark \checkmark$ substitution  $\checkmark$ method  (3)  $\checkmark \checkmark$ substitution  $\checkmark$ method  (3)
5.1.3	$\cos(180^\circ + x)$ $= -\cos x$	$\checkmark - \checkmark \cos x$ (2)
5.2	$\frac{\cos(90^\circ + \theta)}{\sin(\theta - 180^\circ) + 3\sin(-\theta)}$ $= \frac{-\sin \theta}{\sin(-(180^\circ - \theta)) - 3\sin \theta}$ $= \frac{-\sin \theta}{-\sin \theta - 3\sin \theta}$ $= \frac{-\sin \theta}{-4\sin \theta}$ $= \frac{1}{4}$	$\checkmark - \sin \theta$ $\checkmark - 3\sin \theta$  $\checkmark - \sin \theta$  $\checkmark$ simplification  $\checkmark$ answer  (5)

**DEPARTMENT OF BASIC EDUCATION**  
 PRIVATE BAG X898, PRETORIA 0001  
 2022 -11- 16  
**APPROVED MARKING GUIDELINE**  
**PUBLIC EXAMINATION**

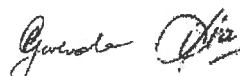

<p>5.3</p>	<p><math>(\cos x + 2 \sin x)(3 \sin 2x - 1) = 0</math></p> <p><math>\cos x + 2 \sin x = 0</math>                      or                      <math>3 \sin 2x - 1 = 0</math></p> <p><math>\tan x = -\frac{1}{2}</math>    <math>\sin 2x = \frac{1}{3}</math></p> <p>ref <math>\angle = 26,565 \dots^\circ</math>    ref <math>\angle = 19,471 \dots^\circ</math></p> <p><math>x = 153,43^\circ + k.180^\circ; k \in Z</math>    <math>x = 9,74^\circ + k.180^\circ; k \in Z</math></p> <p style="text-align: center;"><b>OR/OF</b>    or</p> <p><math>x = 153,43^\circ + k.360^\circ; k \in Z</math>    <math>x = 80,26^\circ + k.180^\circ;</math></p> <p style="text-align: center;">or</p> <p><math>x = 333,43^\circ + k.360^\circ; k \in Z</math></p>	<p>✓ both equations</p> <p>✓ <math>\tan x = -\frac{1}{2}</math></p> <p>✓ <math>\sin 2x = \frac{1}{3}</math></p> <p>✓ <math>x = 153,43^\circ</math> <b>OR</b>  <math>x = 153,43^\circ \text{ \&amp; } 333,43^\circ</math></p> <p>✓ <math>x = 9,74^\circ \text{ \&amp; } 80,26^\circ</math></p> <p>✓ <math>+ k.180^\circ; k \in Z</math></p> <p style="text-align: right;">(6)</p>
<p>5.4.1</p>	<p>LHS = <math>\cos(x + y) \cdot \cos(x - y)</math></p> <p>= <math>[\cos x \cdot \cos y - \sin x \cdot \sin y][\cos x \cdot \cos y + \sin x \cdot \sin y]</math></p> <p>= <math>\cos^2 x \cdot \cos^2 y - \sin^2 x \cdot \sin^2 y</math></p> <p>= <math>(1 - \sin^2 x)(1 - \sin^2 y) - \sin^2 x \cdot \sin^2 y</math></p> <p>= <math>1 + \sin^2 x \cdot \sin^2 y - \sin^2 x - \sin^2 y - \sin^2 x \cdot \sin^2 y</math></p> <p>= <math>1 - \sin^2 x - \sin^2 y = \text{RHS}</math></p>	<p>✓ expansion</p> <p>✓ simplification</p> <p>✓ square identity</p> <p>✓ product</p> <p style="text-align: right;">(4)</p>
<p>5.4.2</p>	<p><math>1 - \sin^2 45^\circ - \sin^2 15^\circ</math></p> <p>= <math>\cos(45^\circ + 15^\circ) \cdot \cos(45^\circ - 15^\circ)</math></p> <p>= <math>\cos 60^\circ \cdot \cos 30^\circ</math></p> <p>= <math>\left(\frac{1}{2}\right)\left(\frac{\sqrt{3}}{2}\right)</math></p> <p>= <math>\frac{\sqrt{3}}{4}</math></p> <p><b>OR/OF</b></p> <div style="text-align: center; border: 1px solid black; padding: 5px; margin: 10px auto; width: fit-content;"> <p>DEPARTMENT OF BASIC EDUCATION</p> <p>PRIVATE BAG X885, PRETORIA 0001</p> <p>2022 -11- 16</p> <p>APPROVED MARKING GUIDELINE</p> <p>PUBLIC EXAMINATION</p> </div>	<p>✓ identifying x and y</p> <p>✓ substitution</p> <p>✓ answer</p> <p style="text-align: right;">(3)</p>

$$\begin{aligned}
 &1 - \sin^2 45^\circ - \sin^2 15^\circ \\
 &= \sin^2 15^\circ + \cos^2 15^\circ - \sin^2 45^\circ - \sin^2 15^\circ \\
 &= \cos^2 15^\circ - \left(\frac{\sqrt{2}}{2}\right)^2 \\
 &= \cos^2 15^\circ - \frac{1}{2} \\
 &= \frac{2 \cos^2 15^\circ - 1}{2} \\
 &= \frac{\cos 30^\circ}{2} \\
 &= \frac{\sqrt{3}}{2} \times \frac{1}{2} \\
 &= \frac{\sqrt{3}}{4}
 \end{aligned}$$

✓ identity

✓ substitution

✓ answer

(3)

OR

$$\begin{aligned}
 &1 - \sin^2 45^\circ - \sin^2 15^\circ \\
 &= \cos^2 45^\circ - \sin^2 (45^\circ - 30^\circ) \\
 &= \left(\frac{1}{\sqrt{2}}\right)^2 - (\sin 45^\circ \cos 30^\circ - \cos 45^\circ \sin 30^\circ)^2 \\
 &= \frac{1}{2} - \left(\frac{1}{\sqrt{2}} \times \frac{\sqrt{3}}{2} - \frac{1}{\sqrt{2}} \times \frac{1}{2}\right)^2 \\
 &= \frac{1}{2} - \left(\frac{\sqrt{3}}{2\sqrt{2}} - \frac{1}{2\sqrt{2}}\right)^2 \\
 &= \frac{1}{2} - \left(\frac{\sqrt{3}}{2\sqrt{2}} - \frac{1}{2\sqrt{2}}\right)^2 \\
 &= \frac{1}{2} - \left(\frac{3}{8} - \frac{\sqrt{3}}{4} + \frac{1}{8}\right) \\
 &= \frac{\sqrt{3}}{4}
 \end{aligned}$$

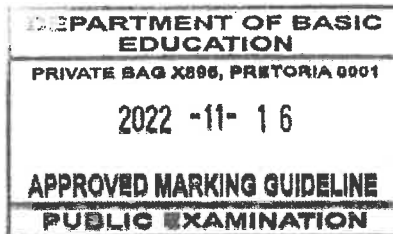

✓ expansion

✓ substitution

✓ answer

(3)

5.5.1

$$\begin{aligned}
 &16 \sin x \cdot \cos^3 x - 8 \sin x \cdot \cos x \\
 &= 8 \sin x \cdot \cos x (2 \cos^2 x - 1) \\
 &= 4 \sin 2x (\cos 2x) \\
 &= 2 \sin 4x
 \end{aligned}$$

✓ factorisation

✓ 4sin2x ✓ cos2x

	<p><b>OR/OF</b></p> $16 \sin x \cdot \cos^3 x - 8 \sin x \cdot \cos x$ $= 16 \cos^2 x \left( \frac{1}{2} \sin 2x \right) - 8 \left( \frac{1}{2} \sin 2x \right)$ $= 8(2 \cos^2 x - 1) \left( \frac{1}{2} \sin 2x \right)$ $= 4 \sin 2x \cdot \cos 2x$ $= 2 \sin 4x$	<p>✓ double angle (4)</p> <p>✓ factorisation</p> <p>✓ 4 sin 2x ✓ cos 2x</p> <p>✓ double angle (4)</p>
5.5.2	$16 \sin x \cdot \cos^3 x - 8 \sin x \cdot \cos x = 2 \sin 4x$ Minimum at $x = 67,5^\circ$	<p>✓ answer (1)</p>
		<b>[30]</b>

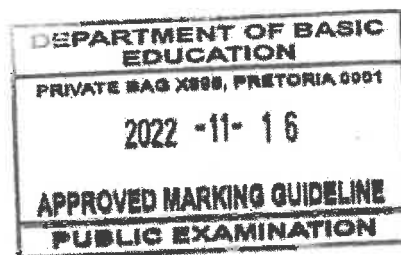

QUESTION/VRAAG 6

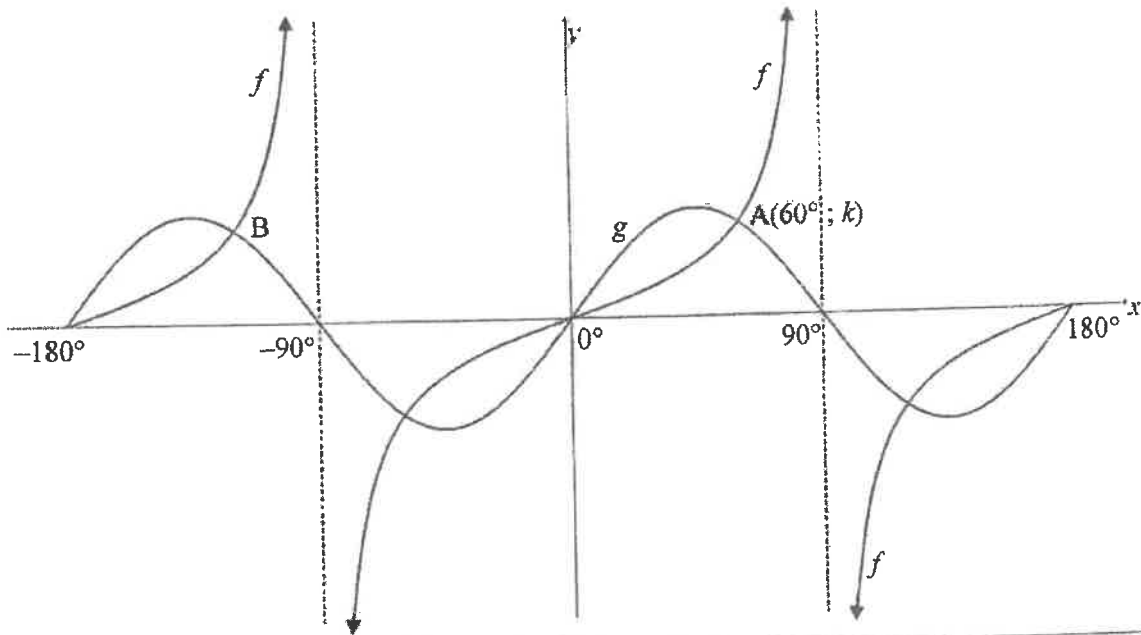

6.1	$180^\circ$	✓ answer	(1)
6.2.1	$k = \sqrt{3} = 1,73$	✓ answer	(1)
6.2.2	$B(-120^\circ; \sqrt{3})$	✓ $x = -120^\circ$	(1)
6.3	Range of $g$ : $y \in [-2; 2]$ Range of $2g(x)$ : $y \in [-4; 4]$  <b>OR/OF</b> Range of $g$ : $-2 \leq y \leq 2$ Range of $2g(x)$ : $-4 \leq y \leq 4$	✓ $y \in [-2; 2]$ ✓ answer  ✓ $-2 \leq y \leq 2$ ✓ answer	(2)
6.4	$x \in [-65^\circ; -5^\circ]$  <b>OR/OF</b> $-65^\circ \leq x \leq -5^\circ$	✓✓ $x \in [-65^\circ; -5^\circ]$  ✓✓ $-65^\circ \leq x \leq -5^\circ$	(2)
6.5	$\sin x \cdot \cos x = p$ $4 \sin x \cdot \cos x = 4p$ $2 \sin 2x = 4p$  $4p = \pm 2$ $\therefore p = -\frac{1}{2} \text{ or } \frac{1}{2}$	✓ $2 \sin 2x = 4p$ ✓ $4p = \pm 2$ ✓ answers	(3)

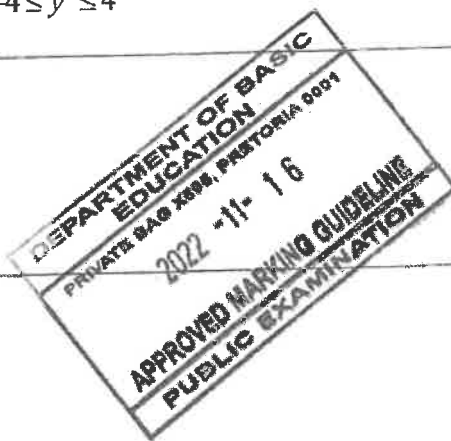

ANSWER ONLY: Full marks

[10]

QUESTION/VRAAG 7

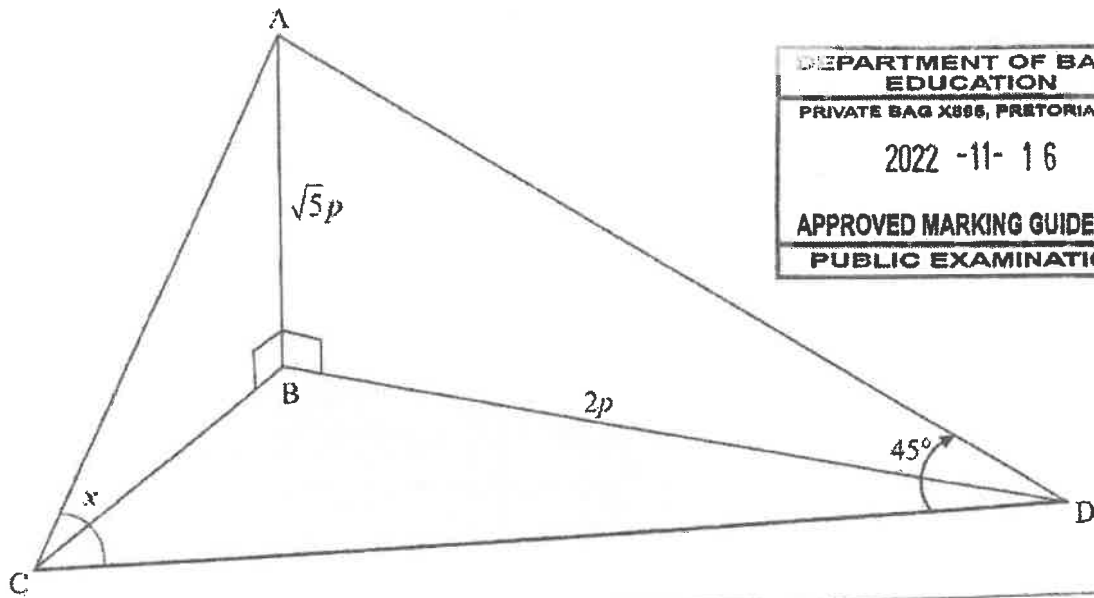

DEPARTMENT OF BASIC  
EDUCATION  
PRIVATE BAG X896, PRETORIA 0001  
2022 -11- 16  
APPROVED MARKING GUIDELINE  
PUBLIC EXAMINATION

7.1	$AD^2 = AB^2 + BD^2$ $AD^2 = (\sqrt{5}p)^2 + (2p)^2$ $AD^2 = 9p^2$ $AD = 3p$	✓ substitution in Pythagoras  ✓ answer (2)
7.2	$\frac{CD}{\sin(135^\circ - x)} = \frac{3p}{\sin x}$ $CD = \frac{3p \sin(135^\circ - x)}{\sin x}$ $CD = \frac{3p(\sin 135^\circ \cos x - \cos 135^\circ \sin x)}{\sin x}$ $CD = \frac{3p(\sin 45^\circ \cos x + \cos 45^\circ \sin x)}{\sin x}$ $CD = \frac{3p\left(\frac{\sqrt{2}}{2} \cos x + \frac{\sqrt{2}}{2} \sin x\right)}{\sin x}$ $CD = \frac{3p\left(\frac{\sqrt{2}}{2}\right)(\cos x + \sin x)}{\sin x}$ $CD = \frac{3p(\sin x + \cos x)}{\sqrt{2} \sin x}$	✓ correct use of sine rule  ✓ $135^\circ - x$  ✓ compound angle  ✓ special values  ✓ factorisation (5)



7.3	$\text{Area } \triangle ADC = \frac{1}{2}(AD)(CD)\sin\hat{A}DC$ $= \frac{1}{2}(3p)\left(\frac{3p(\sin x + \cos x)}{\sqrt{2}\sin x}\right)(\sin 45^\circ)$ $= \frac{1}{2}(30)\left(\frac{30(\sin 110^\circ + \cos 110^\circ)}{\sqrt{2}\sin 110^\circ}\right)\sin 45^\circ$ $= 143,11\text{m}^2$	✓ correct use of area rule  ✓ substitution in area rule ✓ answer (3)
		<b>10</b>

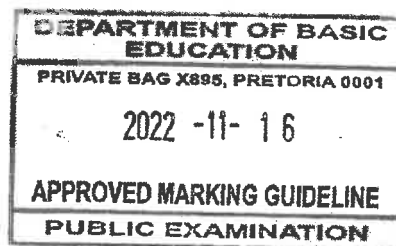

QUESTION/VRAAG 8

8.1

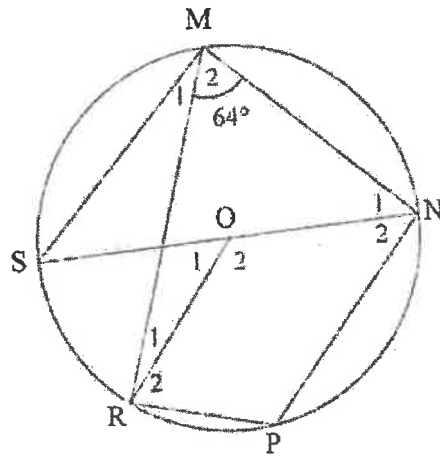

8.1.1	$\hat{P} = 116^\circ$	[opp $\angle$ s of cyclic quad/teenoorst. $\angle$ e van kvh]	$\checkmark$ S $\checkmark$ R	(2)
8.1.2	$\hat{M}_1 + 64^\circ = 90^\circ$ $\hat{M}_1 = 26^\circ$	[ $\angle$ in semi-circle/ $\angle$ in halwe sirkel]	$\checkmark$ R $\checkmark$ S	(2)
8.1.3	$\hat{O}_1 = 52^\circ$	[ $\angle$ at centre = $2 \times \angle$ at circumference/midpts. $\angle$ = $2 \times$ omtreks. $\angle$ ]	$\checkmark$ S $\checkmark$ R	(2)

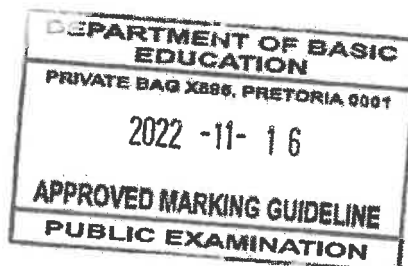

Copyright reserved/Kopiereg voorbehou

*Quenda* *Phu*

Please turn over/Blaai om asseblief

8.2

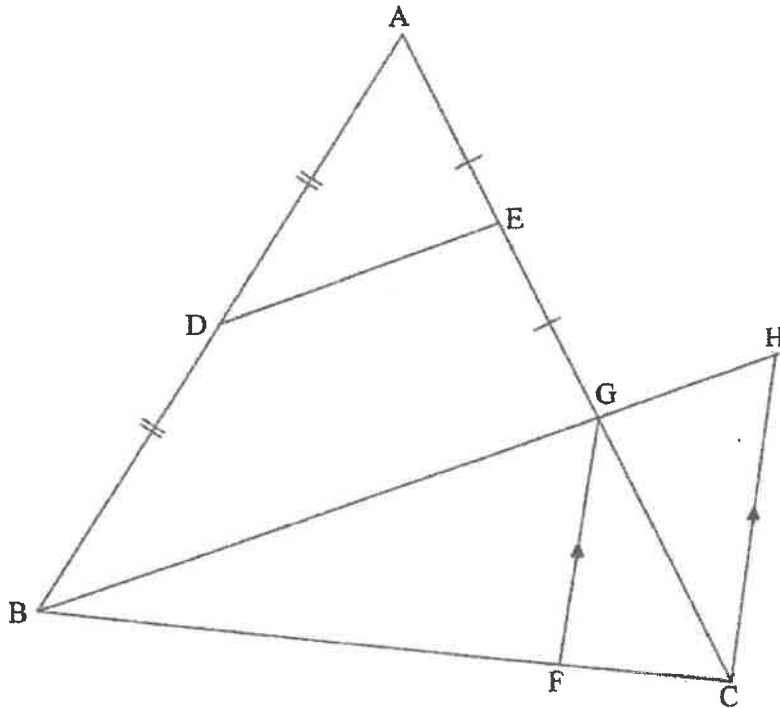

8.2.1	Midpt theorem/Midpt. Stelling	✓ R (1)
	<b>OR/OF</b>	
	Converse prop intercept theorem	✓ R (1)
8.2.2	$BG = 2DE$ or $6x - 2$ [Midpt theorem/Midpt. stelling]	✓ S ✓ R
	$BG = 6x - 2$	✓ S ✓ R
	$\frac{GH}{BG} = \frac{FC}{BF}$	[line    one side of $\Delta$ OR prop theorem; $FG \parallel CH$ / lyn    een sy v. $\Delta$ ]
	$\frac{x+1}{6x-2} = \frac{1}{4}$	✓ equation into x
	$4x + 4 = 6x - 2$	
	$2x = 6$	
	$x = 3$	✓ answer (6)
	<b>OR/OF</b>	

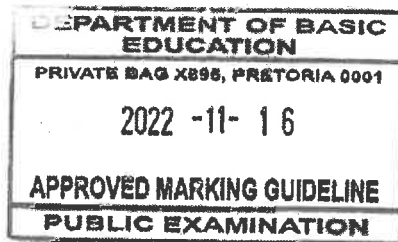

	$\frac{BF}{FC} = \frac{BG}{GH}$ <p>[line    one side of <math>\Delta</math> OR prop theorem; FG    CH / lyn    een sy v. <math>\Delta</math>]</p>	✓ S ✓ R
	$\frac{AE}{AG} = \frac{DE}{BG}$ <p>[<math>\Delta ADE \parallel \Delta ABG</math>]</p>	✓ S ✓ R
	$BG = 4x + 4$	
	$\frac{1}{2} = \frac{3x-1}{4x+4}$	✓ equation into x
	$\therefore 4x + 4 = 6x - 2$	
	$\therefore x = 3$	✓ answer
		(6)
		[13]

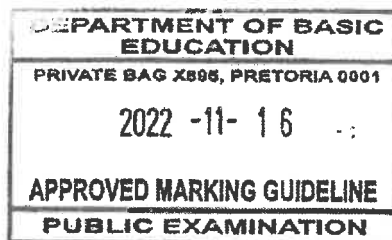

**QUESTION/VRAAG 9**

9.1

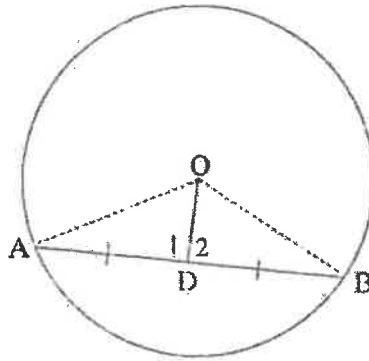

<p>9.1.1</p>	<p>Construction:                  Draw OA and OB                  In <math>\triangle ADO</math> and <math>\triangle BDO</math>  <math>OA = OB</math> [radii/radiusse]  <math>OD = OD</math> [common side/gemeenskaplike sy]  <math>AD = DB</math> [given/gegee]  <math>\therefore \triangle ADO \cong \triangle BDO</math> [S;S;S]                  ADB is a straight line  <math>\therefore \hat{D}_1 = \hat{D}_2</math> <math>\triangle ADO \cong \triangle BDO</math>  <math>\therefore OD \perp AB</math> [<math>\angle</math>s on a str line/<math>\angle</math>e op 'n reguitlyn]</p> <p><b>OR/OF</b>                  Construction:                  Draw OA and OB                  In <math>\triangle ADO</math> and <math>\triangle BDO</math>  <math>AD = DB</math> [given/gegee]  <math>\hat{A} = \hat{B}</math> [<math>\angle</math>s opp; <math>\angle</math>s sides / <math>\angle</math>e teenoor gelyke sye]  <math>OA = OB</math> [radii/radiusse]  <math>\therefore \triangle ADO \cong \triangle BDO</math> [S;<math>\angle</math>;S]                  ADB is a straight line  <math>\therefore \hat{D}_1 = \hat{D}_2</math> <math>\triangle ADO \cong \triangle BDO</math>  <math>\therefore OD \perp AB</math> [<math>\angle</math>s on a str line/<math>\angle</math>e op 'n reguitlyn]</p>	<p>✓ construction</p> <p>✓ first pair of sides                  ✓ other 2 pairs                  ✓ R</p> <p>✓ R</p> <p>(5)</p> <p>✓ construction</p> <p>✓ first pair of sides</p> <p>✓ other 2 pairs                  ✓ R</p> <p>✓ R</p> <p>(5)</p>
--------------	--	---

**DEPARTMENT OF BASIC EDUCATION**  
 PRIVATE BAG X895, PRETORIA 0001  
 2022 -11- 16  
**APPROVED MARKING GUIDELINE**  
**PUBLIC EXAMINATION**

*Handwritten signatures*

9.2

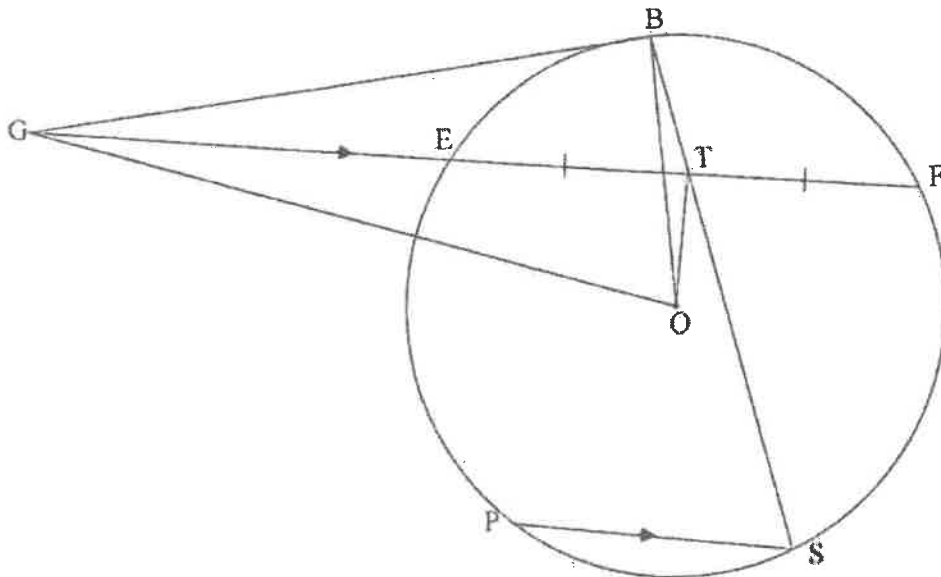

<p>9.2.1</p>	<p><math>\hat{O}TG = 90^\circ</math>  <math>\hat{O}BG = 90^\circ</math>  <math>\therefore \hat{O}TG = \hat{O}BG = 90^\circ</math>  <math>\therefore OTBG</math> is a cyclic quadrilateral</p>	<p>[line from centre to midpt of chord/  <i>midpt. sirkel; midpt. koord</i>]                  [tan <math>\perp</math> radius/raaklyn <math>\perp</math> radius]                  [line subtends equal <math>\angle</math>s OR                  converse <math>\angle</math>s in the same segment/                  lyn onderspan gelyke <math>\angle</math>e]</p>	<p>✓S ✓R                  ✓S ✓R                  ✓R                  (5)</p>
<p>9.2.2</p>	<p><math>\hat{S} = \hat{B}TG</math>                  But <math>\hat{B}TG = \hat{G}OB</math>  <math>\hat{G}OB = \hat{S}</math></p>	<p>[corresp <math>\angle</math>s; <math>GF \parallel PS</math> /                  ooreenk. <math>\angle</math>s; <math>GF \parallel PS</math>]                  [<math>\angle</math>s in the same segment/<math>\angle</math>e in dies.                  sirkelsegment ]</p>	<p>✓S ✓R                  ✓S ✓R                  (4)</p>
<p>[14]</p>			

**DEPARTMENT OF BASIC EDUCATION**  
 PRIVATE BAG X895, PRETORIA 0001  
 2022 -11- 16  
**APPROVED MARKING GUIDELINE**  
**PUBLIC EXAMINATION**

QUESTION/VRAAG 10

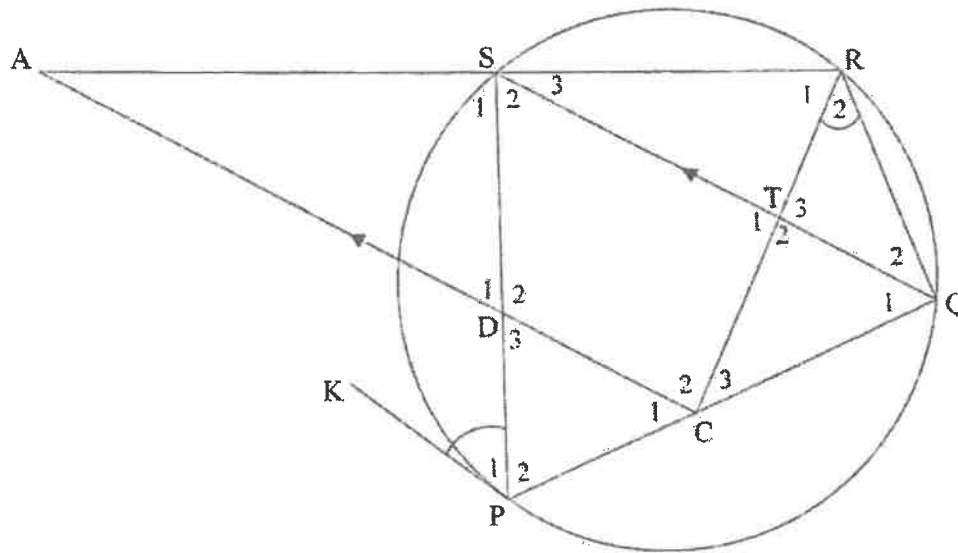

<p>10.1</p>	<p><math>\hat{P}_1 = \hat{Q}_1</math>  <math>\hat{S}_1 = \hat{Q}_1 + \hat{Q}_2</math>  <math>\therefore \hat{S}_1 = \hat{P}_1 + \hat{Q}_2</math>  <math>\hat{T}_2 = \hat{R}_2 + \hat{Q}_2</math>                  but <math>\hat{P}_1 = \hat{R}_2</math>  <math>\hat{I}_2 = \hat{P}_1 + \hat{Q}_2</math>  <math>\therefore \hat{S}_1 = \hat{I}_2 = \hat{P}_1 + \hat{Q}_2</math></p> <p>[tan-chord theorem/ <i>∠ tussen raaklyn en koord</i>]                  [ext <math>\angle</math> of cyclic quad/<i>buite <math>\angle</math> v. kvh</i>]                  [ext <math>\angle</math> of <math>\Delta</math>/<i>buite <math>\angle</math> v. <math>\Delta</math> ]                  [given/<i>gegee</i>]</i></p>	<p>✓ S                  ✓ S / R                  ✓ S                  ✓ S                  (4)</p>
<p>10.2</p>	<p>In <math>\Delta ASD</math> and <math>\Delta ACR</math>  <math>\hat{A} = \hat{A}</math>  <math>\hat{S}_1 = \hat{T}_2</math>  <math>\hat{T}_2 = \hat{C}_2</math>  <math>\therefore \hat{S}_1 = \hat{C}_2</math>  <math>\hat{D}_1 = \hat{R}_1</math>  <math>\Delta ASD \parallel \Delta ACR</math>  <math>\therefore \frac{AD}{AR} = \frac{AS}{AC}</math></p> <p>OR/OF</p> <p>[common <math>\angle</math>/<i>gemeenskaplike <math>\angle</math></i>]                  [proven/<i>reeds bewys</i>]                  [alt <math>\angle</math>s; <math>QS \parallel CA</math>/<i>verw. <math>\angle</math>e; <math>QS \parallel CA</math> ]                  [sum of <math>\angle</math>s in <math>\Delta</math>/<i>e v. <math>\Delta</math></i>]                  [corresponding sides in proportion/<i>ooreenstemmende sy in dies. verhouding</i>]</i></p>	<p>✓ identifying <math>\Delta</math>'s                  ✓ S                  ✓ S / R                  ✓ S                  ✓ S                  (5)</p>

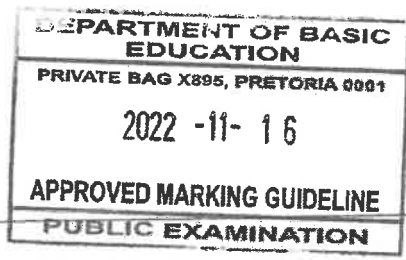

*Handwritten signature*

	<p>In <math>\Delta ASD</math> and <math>\Delta ACR</math>  <math>\hat{A} = \hat{A}</math> [common <math>\angle</math>/gemeenskaplike <math>\angle</math>]  <math>\hat{S}_1 = \hat{T}_2</math> [proven/gegee]  <math>\hat{T}_2 = \hat{C}_2</math> [alt <math>\angle</math>s; QS <math>\parallel</math> CA/verw. <math>\angle</math>e; QS <math>\parallel</math> CA]  <math>\therefore \hat{S}_1 = \hat{C}_2</math>  <math>\Delta ASD \parallel \Delta ACR</math> [<math>\angle</math>; <math>\angle</math>; <math>\angle</math>]  <math>\therefore \frac{AD}{AR} = \frac{AS}{AC}</math> [corresponding sides in proportion/  <i>ooreenstemmende sy in dies. verhouding</i>]</p>	<p>✓ identifying <math>\Delta</math>'s                  ✓ S                  ✓ S/R                  ✓ S                  ✓ R</p> <p>(5)</p>
<p>10.3</p>	<p><math>\frac{AS}{AC} = \frac{SD}{CR}</math> [<math>\Delta ASD \parallel \Delta ACR</math>]  <math>\therefore AS = \frac{AC \times SD}{CR}</math>  <math>\frac{AS}{AR} = \frac{CT}{CR}</math> [line <math>\parallel</math> one side of <math>\Delta</math> OR prop theorem;                  TS <math>\parallel</math> CA/lyn <math>\parallel</math> een sy v. <math>\Delta</math>]  <math>\therefore AS = \frac{AR \times CT}{CR}</math>  <math>\therefore \frac{AC \times SD}{CR} = \frac{AR \times CT}{CR}</math>  <math>\therefore AC \times SD = AR \times CT</math></p>	<p>✓ S                  ✓ S ✓ R                  ✓ equating</p> <p>(4)</p>
		<p>[13]</p>

TOTAL/TOTAAL: 150

